



Scan for full manual

## VS-88UT Quick Start Guide

This guide helps you install and use your VS-88UT for the first time.

Go to [www.kramerav.com/downloads/VS-88UT](http://www.kramerav.com/downloads/VS-88UT) to download the latest user manual and check if firmware upgrades are available.

### Step 1: Check what's in the box

- VS-88UT 8x8 HDMI/HDBT Matrix Switcher
- 1 Power cord
- 1 Quick start guide
- 1 Set of rack ears
- 4 Rubber feet

### Step 2: Get to know your VS-88UT

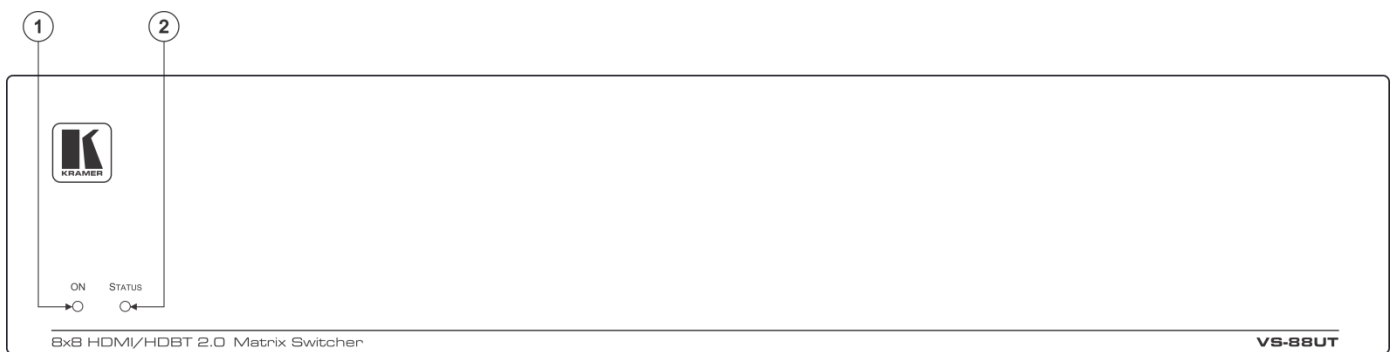

#	Feature	Function
1	ON LED	Lights when receiving power.
2	STATUS LED	Multi-color LED lights upon startup, flashes green upon boot and lights green when ready to use. The LED lights red to indicate internal errors.

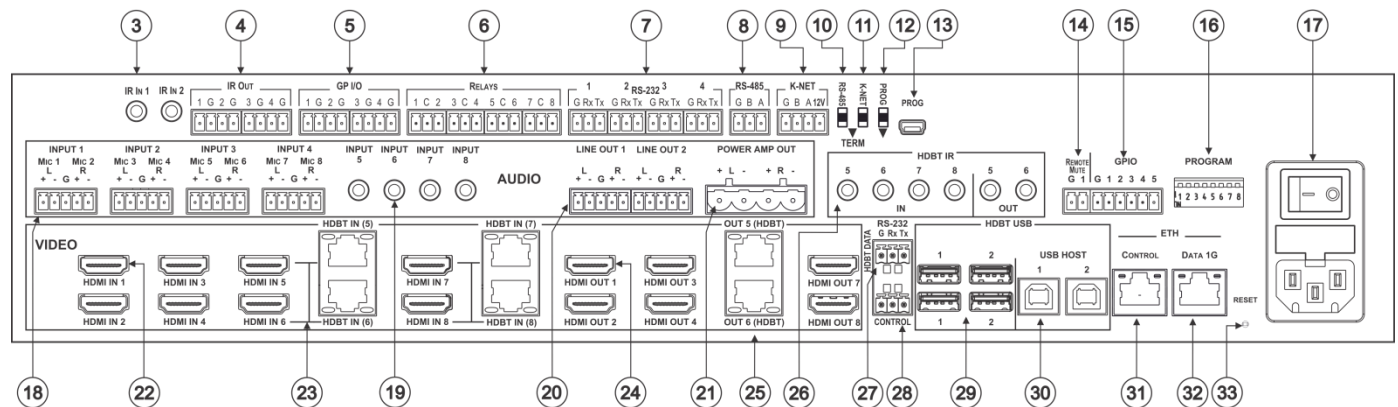

#	Feature	Function
<b>Controller Functionality</b>		
3	IR IN 3.5mm Mini Jack	Connect to an external IR receiver (1 and 2).
4	IR OUT Terminal Block Connectors	Connect to IR emitter cables (from 1 to 4).
5	GPI/O Terminal Block Connectors	Connect to various analog and digital sensors (from 1 to 4).
6	RELAYS Terminal Block Connectors	Connect to low-voltage relay-driven devices (from 1 to 8).
7	RS-232 Terminal Block Connectors	Connect to RS-232 controlled devices (from 1 to 4).
8	RS-485 Terminal Block Connector	Connect to the RS-485 detachable terminal block on a switcher or PC. Pins B (-) and A (+) are for RS-485; Pin G may be connected to the shield (if required).

#	Feature		Function
9	K-NET Terminal Block Connector		Use with the K-Config control system. PIN GND is for the Ground connection; PIN B (-) and PIN A (+) are for RS-485, and PIN +12V is for powering other devices.
10	RS-485 TERM Switch		Slide down for RS-485 termination with 120Ω; slide up for no RS-485 line termination. The first and the last units on the RS-485 line should be terminated (ON). Other units should not be terminated (OFF).
11	K-NET TERM Switch		Use with the K-Config control system. Slide down (in the direction of the arrow) for K-NET termination; slide up for bus to not be terminated. The last physical device on a K-NET bus must be terminated.
12	PROG Switch		For factory use only.
13	PROG Mini USB Connector		For room controller functionalities.
<b>Matrix Functionality</b>			
14	REMOTE MUTE 2-pin Terminal Block Connector		Remote switch to mute the video and audio signals. Enables easy integration of the audio system with PA systems, usually used for alarms or other public audio messages.
15	GPIO Terminal Block Connectors		For future use.
16	PROGRAM DIP-switches		For future use.
17	Power Connector with Switch and Fuse		AC connector, enabling power supply to the unit. Power switch for turning the unit on or off.
18	AUDIO	INPUT (MICx2) 5-pin Terminal Block Connectors	Connect to a stereo audio balanced source (from 1 to 4) or two microphone inputs (from 1 to 8).
19		INPUT 3.5mm Mini Jack	Connect to an unbalanced audio source (from 5 to 8).
20		LINE OUT 5-pin Terminal Block Connectors	Connect to a stereo balanced audio acceptor (1 and 2).
21		POWER AMP OUT 4-pin Terminal Block Connectors	Connect to a pair of loudspeakers.
22	VIDEO	HDMI IN Connector	Connect to an HDMI source (from 1 to 4).
23		HDMI IN—HDBT IN Connectors	Connect a source to the HDMI IN 5 and/or HDMI IN 6 inputs, or connect a transmitter to the HDBT IN (5) and/or HDBT IN (6) inputs. The same applies to the HDMI IN 7/8 and HDBT IN (7)/(8) pairs. For each input pair (HDMI or HDBT), only one type of connector can be enabled (via the Routing Settings Web page); by default, the HDBT pair is active. The HDBT Transmitter (for example, the Kramer <b>TP-590Txr</b> ) can pass audio and video signals as well as USB, Ethernet, power and serial commands (5, 6, 7 and 8).
24		HDMI OUT Connector	Connect to an HDMI acceptor (1, 2, 3, 4, 7 and 8).
25		OUT 5 (HDBT) RJ-45 Connector	Connect to an HDBT receiver (for example, the Kramer <b>TP-590Rxr</b> ) to pass audio and video signals as well as USB, Ethernet, power and serial commands (5 and 6).
26	HDBT IR 3.5mm Mini Jack	IN	Connect to an external IR sensor/emitter to send/receive IR signals (5, 6, 7 and 8) via HDBT inputs 5, 6, 7 and 8 respectively.
		OUT	Connect to an external IR sensor/emitter to send/receive IR signals (5 and 6) via HDBT outputs 5 and 6, respectively.
27	RS-232 HDBT DATA Terminal Block Connectors (G, Rx, Tx)		Connect to the PC or the remote controller and pass data between this RS-232 port and the HDBT OUT ports or one of the HDBT IN ports.
28	RS-232 CONTROL Port Terminal Block Connectors (G, Rx, Tx)		Connect to the PC or the remote controller to control the <b>VS-88UT</b> via Protocol 3000 commands.
29	HDBT USB Device Port Pairs		Connect up to two USB clients to each pair (1 and 2) to pass data via the HDBT inputs or outputs.
30	HDBT USB HOST Ports		Connect to a USB host (1 and 2) to pass data via the HDBT inputs or outputs.
31	ETH RJ-45 Ports	CONTROL	Connect to the PC or other controller through computer networking.
32		DATA 1G	Connect to the PC or other controller via the Ethernet to pass data between HDBT ports and the controller.
33	RESET Recessed Button		Press briefly to restart the system. Press for about 5 seconds to reset settings to factory default values and restart the system.

## Step 3: Install the VS-88UT

To rack mount the machine attach both ear brackets to the machine (by removing the five screws from each side of the machine and replacing those screws through the ear brackets) or place the machine on a table.

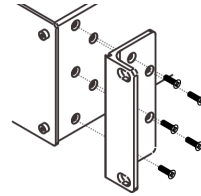

## Step 4: Connect the inputs and outputs

Always switch OFF the power on each device before connecting it to your VS-88UT. For best results, we recommend that you always use Kramer high-performance cables to connect AV equipment to the VS-88UT.

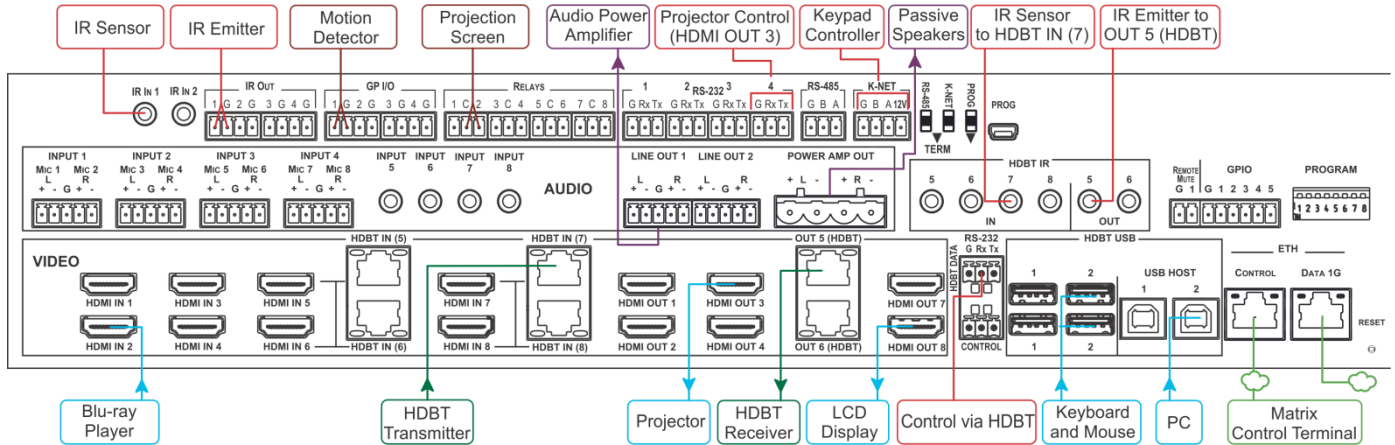

### RJ-45 pinout:

For the Ethernet and HDBaseT connectors, see the proper wiring diagram below

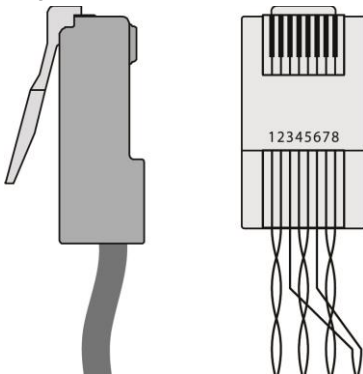

PIN EIA /TIA 568B	
PIN	Wire Color
1	Orange / White
2	Orange
3	Green / White
4	Blue
5	Blue / White
6	Green
7	Brown / White
8	Brown

### Connect the audio input:

To a balanced stereo audio source:

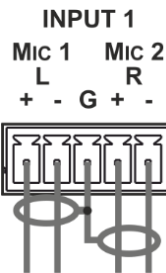

### Connect the audio output:

To a balanced stereo audio acceptor

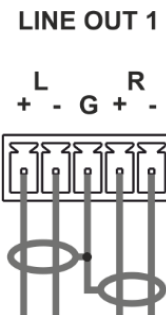

To an unbalanced stereo audio source:

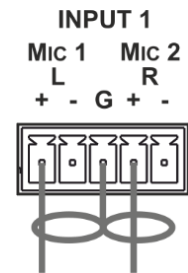

To an unbalanced stereo audio acceptor

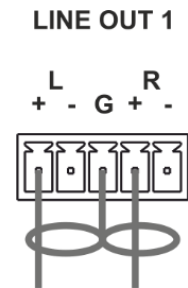

## Step 5: Connect the power

Connect AC power to the rear of the VS-88UT, switch on its power and then switch on the power on each device.

### Safety Instructions



- Caution:** There are no operator serviceable parts inside the unit.
  - Warning:** Use only the power cord that is supplied with the unit.
  - Warning:** Do not open the unit. High voltages can cause electrical shock! Servicing by qualified personnel only.
  - Warning:** Disconnect the power and unplug the unit from the wall before installing.
- See [www.KramerAV.com](http://www.KramerAV.com) for updated safety information.

## Step 6: Operate via the Web pages:

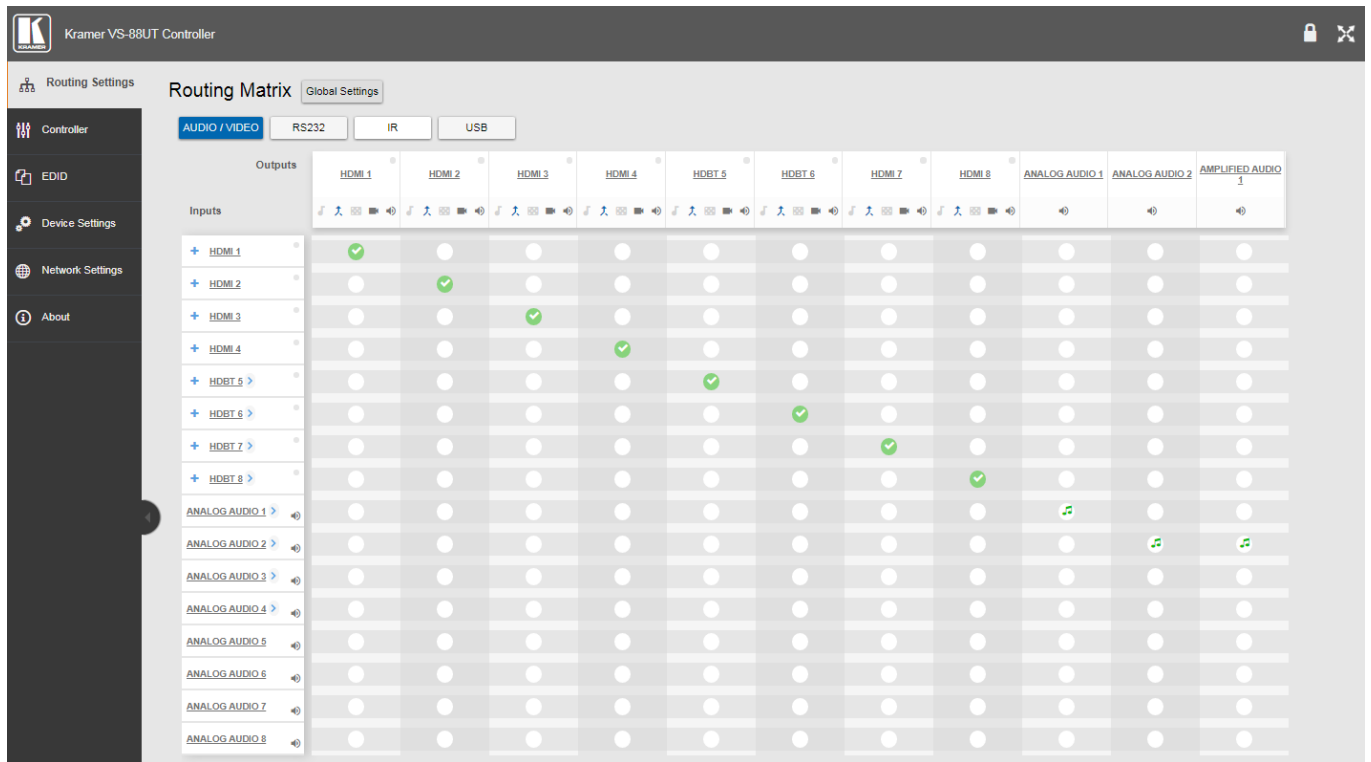

### Route video and audio signals:

Click a white button in the matrix to route an input to an output (audio and/or video).

	Optional input to output routing.		Video only is routed.		An active signal is detected (for inputs and outputs).
	Current input to output routing state.		Audio only is routed.		No active signal is detected (for inputs and outputs).

### Additional functions:

<b>Inputs:</b>	HDMI and HDBT	Click the input name to change its settings. Click <b>+</b> to route the audio and video inputs separately. Click <b>&gt;</b> to toggle between the HDBT and HDMI input.
	Analog Audio	Click the input name to change its settings. Click  to change audio level settings. Click <b>&gt;</b> to toggle between one analog input signal and two mic. Input signals.
<b>Outputs:</b>	HDMI and HDBT	Click the output name to change its settings.
		Audio-only mode is enabled/disabled.
		HDMI is on/off.
		Audio-follow-video mode is enabled/disabled.
		AUDIO is on/off.
		Pattern is selected/not selected.

Analog and Amplified Audio: Click to change audio settings.

### Default communication parameters:

<b>RS-232</b>			
Protocol 3000			
Baud Rate:	115,200	Stop Bits:	1
Data Bits:	8	Parity:	None
Example (Set the volume on analog audio input 5 to 10dB):		#X-AUD-LVL IN.ANALOG_AUDIO.5.AUDIO.1,10	
<b>TCP/IP Parameters</b>			
IP Address:	192.168.1.39	UDP Port #:	50000
Subnet mask:	255.255.000.000	Maximum UDP Connections:	Unlimited
Default gateway:	192.168.0.1	Maximum TCP Connections:	Unlimited
TCP Port #:	5000		
<b>Full Factory Reset</b>			
Protocol 3000	Use "#FACTORY" command and use "#RESET" to restore the factory default values.		